

13052 - TW MDL 60 'P' TYPE 1/2" SQ. DR. PTR

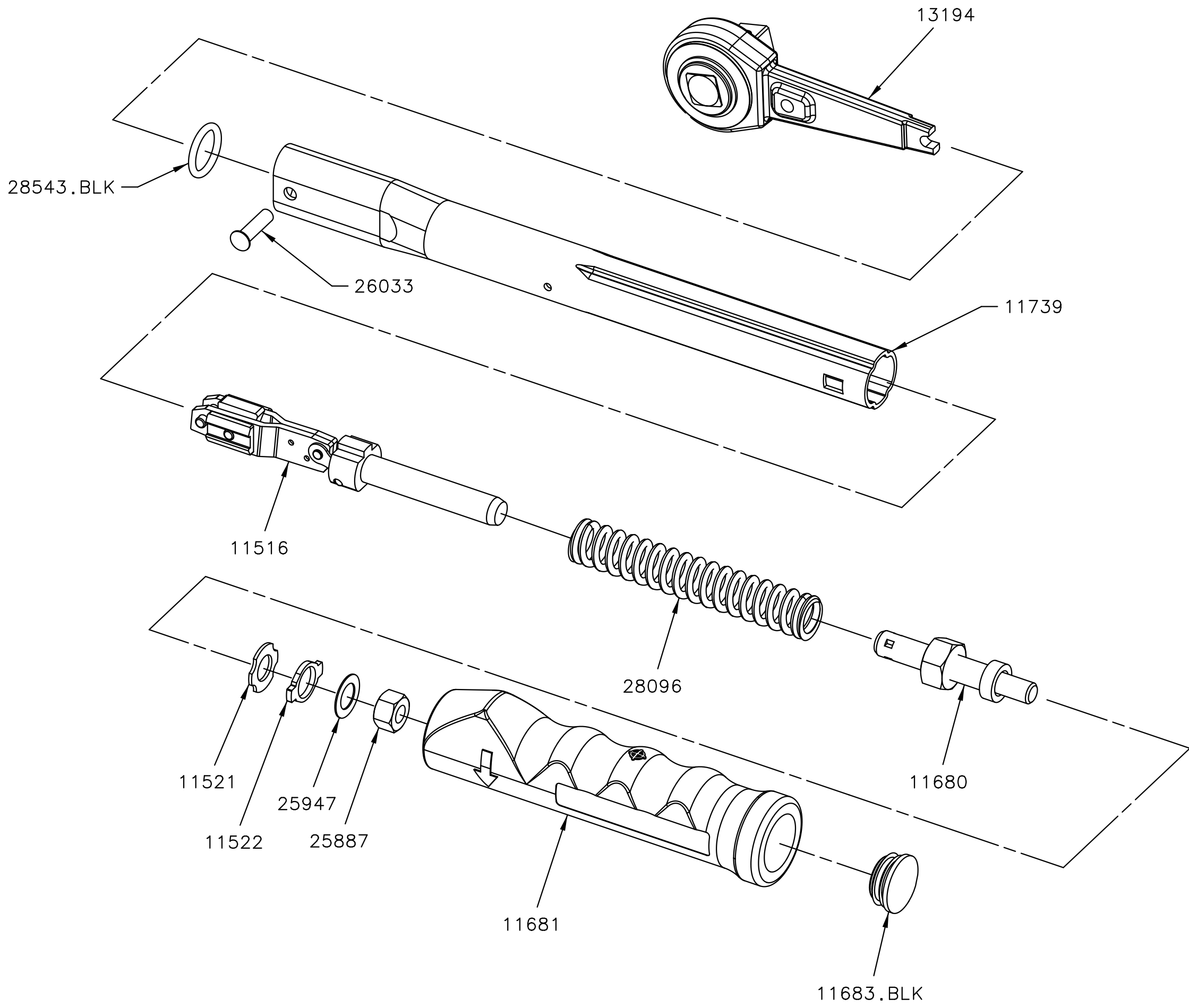

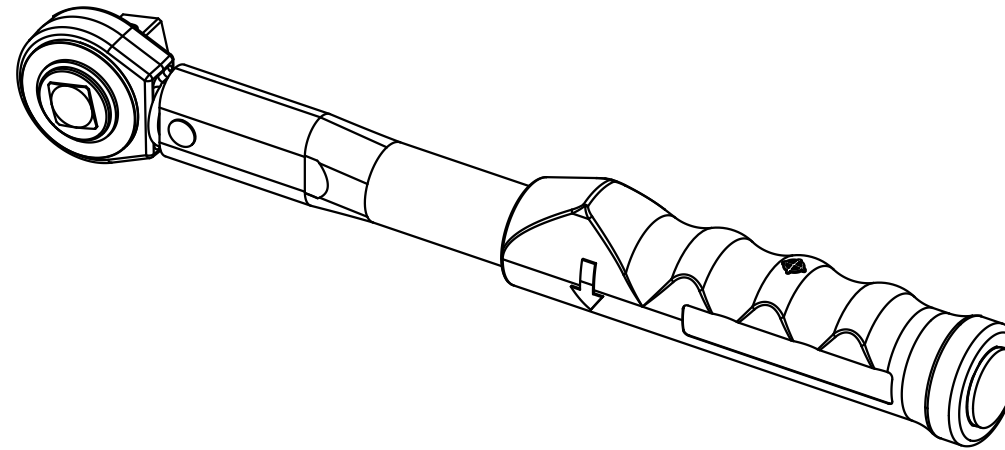

11516	1	TRANSVERSE LINK ASSY PROFESSIONAL
11521	1	SHAPED WASHER
11522	1	END STOP
11680	1	ADJUSTING NUT AND SCREW P TYPE THREADED END
11681	1	HANDLE P TYPE PRESS ON
11682	1	SOCKET 13mm AF FOR P TYPE PROFESSIONAL ADJUSTING
11683.BLK	1	END CAP DOMED P TYPE PROF BLACK
11739	1	MDL60 BODY TUBE FOR PROF.
13194	1	RATCHET ASSY MDL60 1/2 3-PAWL
25887	1	HEX.NUT.M8 H.TEN.
25947	1	WASHER .39/.395 x .65 x .018 REF SR 126J
26033	1	PIVOT PIN TES 3487
28096	1	COMP. SPRING FOR TW MACHANISM
28543.BLK	1	O RING BLACK VITON 15.54 ID
Part No	Qty	Description