

14007 - 1000 P TYPE 3/4" RATCHET

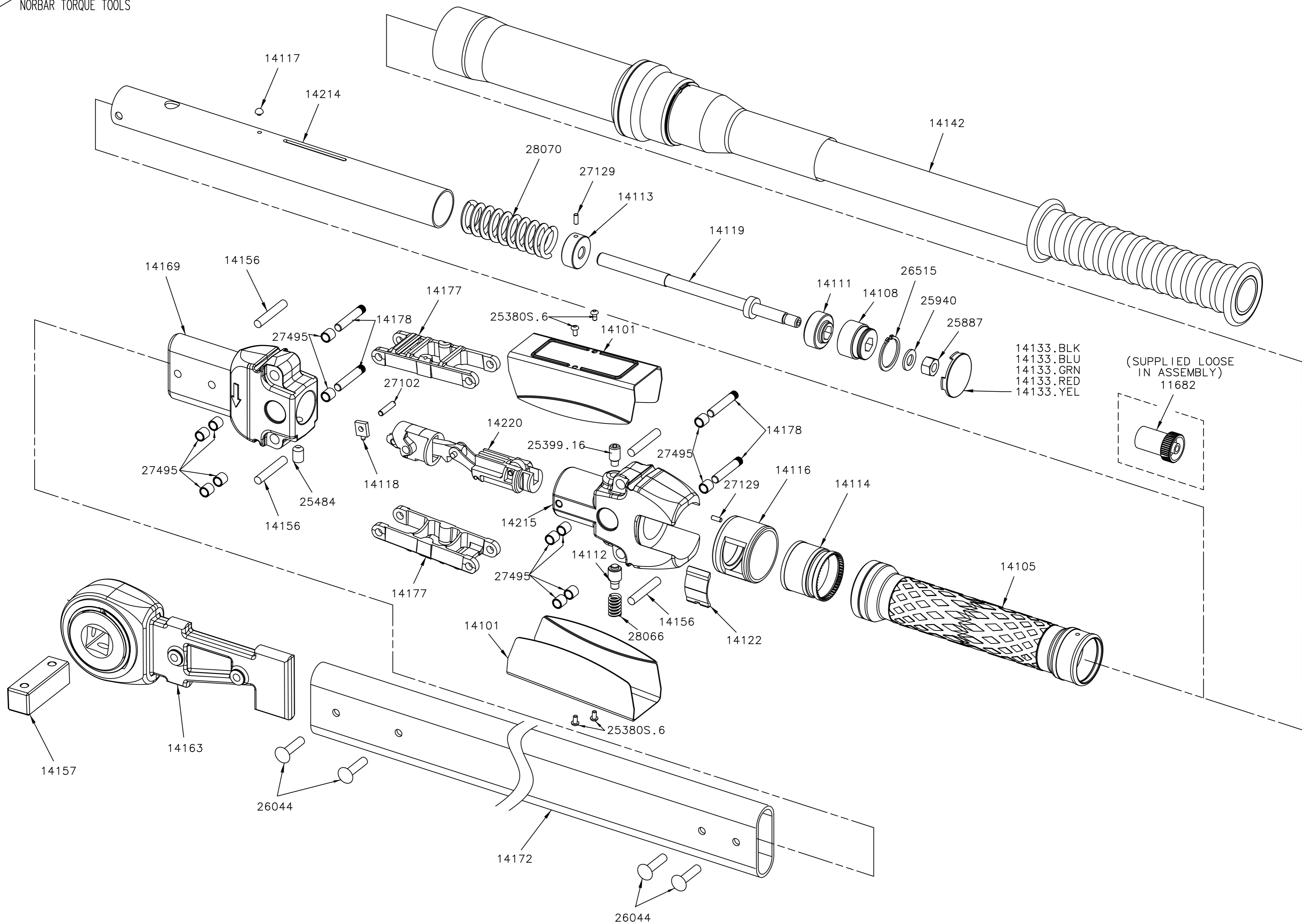

14007 - 1000 P TYPE 3/4" RATCHET

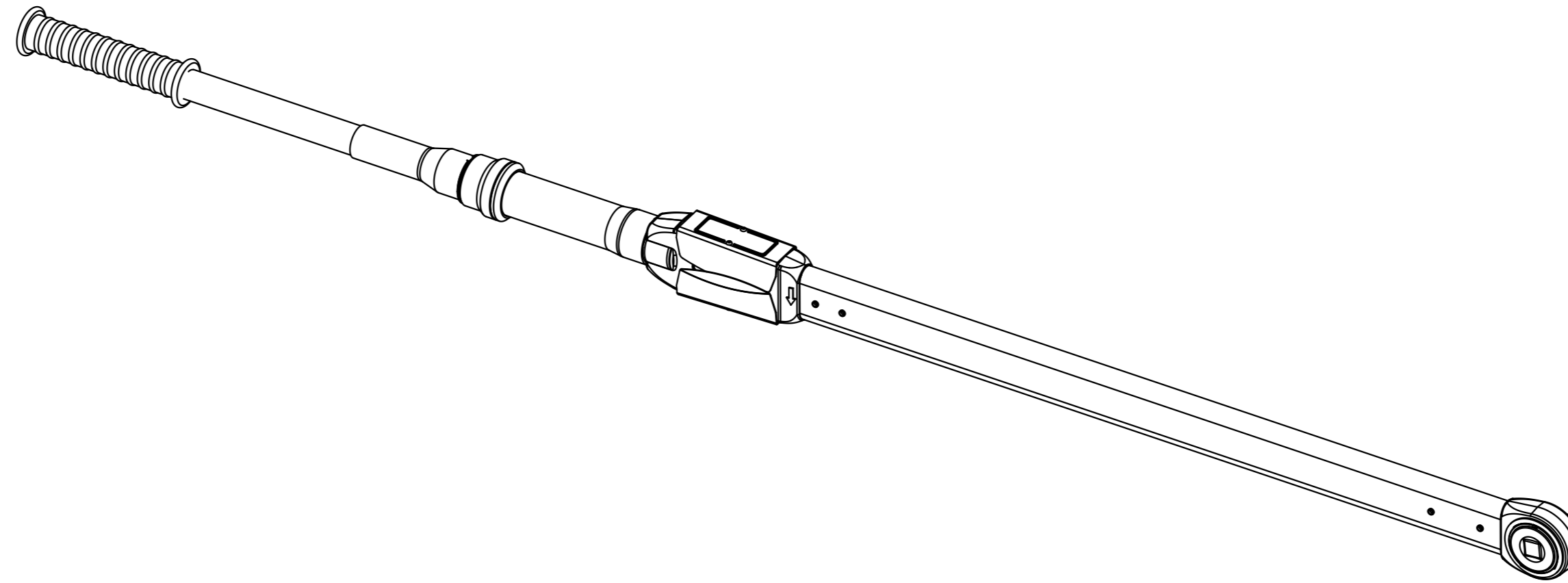

28070	1	COMP.SPRING 250D.x75LGx3.30WD
28066	1	SPRG/COMP 9.6 O/D x 14.5 LG
27495	12	DU BUSH 6 I/D x 8 LONG MB0608DU
27138	1	CYLINDRICAL ROLLER DIA 6 X 36 LG
27129	2	NEEDLE ROLLER DIA 3.0 x 7.8
27102	1	NEEDLE ROLLER 4 DIA X 17.8
26515	1	CRCLP 24MM DIA EXT. TO DIN 471
26044	4	RIVET SEMI-TUBE MDL 1000/1500
25940	1	WASHER M8 STD. BR ZINC PLATE
25887	1	HEX.NUT.M8 H.TEN.
25484	1	PIVOT SCREW
25399.16	1	SSS M8x16LG HALF DOG POINT
25380S.6	4	M3 X 6 BUT.HD STAINLESS TUFLOK
14220	1	SECONDARY LEVER ASSY FOR MDL 500-1500
14215	1	REAR SUPPORT BLOCK MDL550-1500 [Mk2]
14214	1	HANDLE TUBE FOR MDL 550-1500 [Mk2]
14178	4	PIVOT PIN UPRATED
14177	2	LINK FRAME MDL 550-1500 UPRATED VERSION
14172	1	BODY TUBE MODEL 1000
14169	1	FRONT SUPPORT BLOCK 1000Nm
14163	1	RATCHET ASSY MDL1000/1500
14157	1	SQ DR ASSY 3/4 MDL 1000
14156	4	SEAL 6MM DIA x 36LG NEO. CORD MDL 550-1500
14142	1	EXTENSION HANDLE ASSEMBLY MDL 550-1500
14133.YEL	1	END CAP P TYPE-YELLOW
14133.RED	1	END CAP P TYPE-RED
14133.GRN	1	END CAP P TYPE-GREEN
14133.BLU	1	END CAP P TYPE-BLUE
14133.BLK	1	END CAP P TYPE-BLACK
14122	1	SCALE LENS COVER MDL 550-1500
14119	1	ADJUSTING SCREW P TYPE MDL 550-1500
14118	1	SECONDARY LEVER PIVOT PIN MDL 550-1500
14117	1	LOCKING PIN P TYPE MDL 550-1500
14116	1	SCALE MECHANISM COVER MDL 550-1500
14114	1	SCALE ROTATING GEAR MDL 550-1500
14113	1	ADJUSTING NUT MDL 550-1500
14112	1	DAMPING PISTON MDL 550-1500
14111	1	LOCK NUT
14108	1	HANDLE ARBOR P TYPE MDL 550-1500
14105	1	HANDLE SLEEVE MODEL 550-1500
14101	2	SADDLE PLATE MDL 550-1500
11682	1	SOCKET 13mm AF FOR P TYPE PROFESSIONAL ADJUSTING
Part No	Qty	Description